

| | |
|---|--|
|  | 357 rue Franquet, Quebec, QC G1P 4N7, Canada; Tel: 418 877 5600; doriclenses.com; |
| | TITLE: Generic MFP Termination for FC (KIENTEC)-1100 and less |
| DWG. NO. | S212-0003 |
| DO NOT SCALE DRAWING | 11-7-2022 |

Dimensions in mm
 For Information Purposes Only

PROPRIETARY
 THE INFORMATION CONTAINED IN THIS DRAWING
 IS THE SOLE PROPERTY OF **Doric Lenses Inc.**
 ANY REPRODUCTION IN PART OR AS A WHOLE
 WITHOUT THE WRITTEN PERMISSION OF
Doric Lenses Inc. IS PROHIBITED.

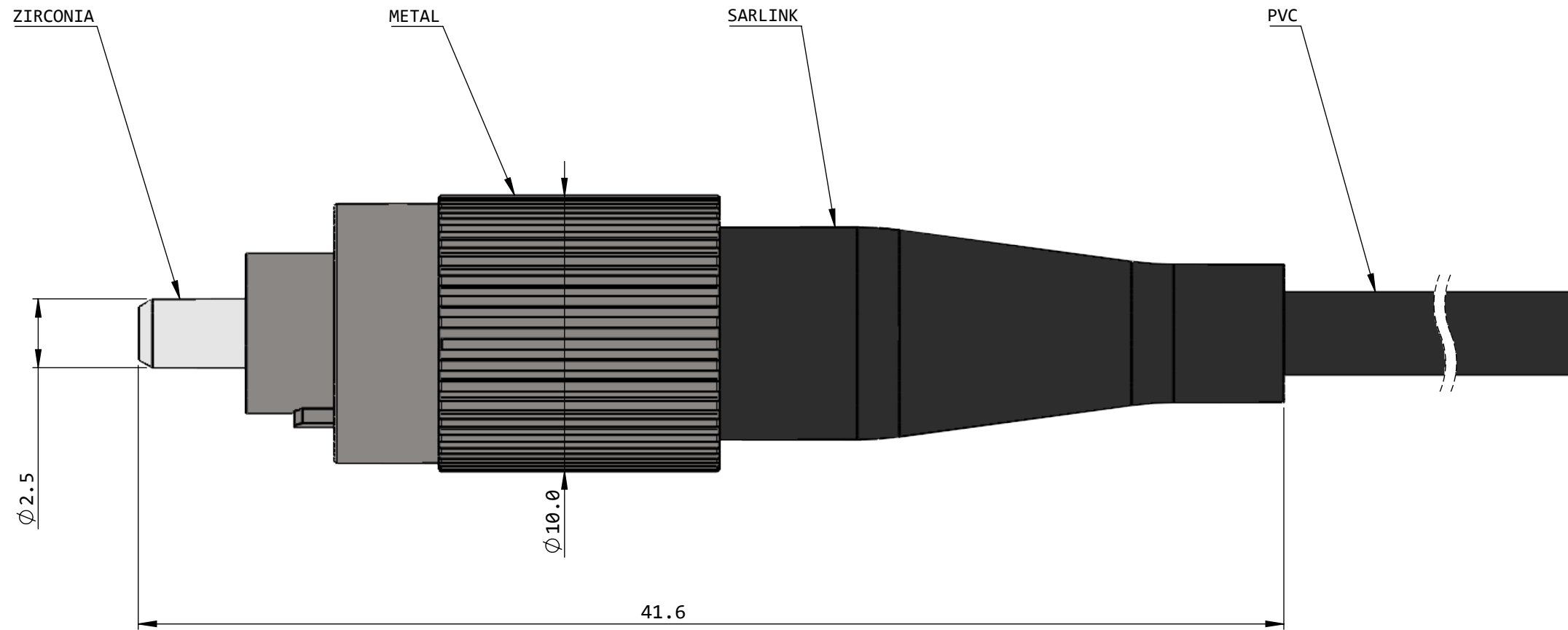

Dimensions in mm
For Information Purposes Only

PROPRIETARY
THE INFORMATION CONTAINED IN THIS DRAWING IS THE SOLE PROPERTY OF Doric Lenses Inc.. ANY REPRODUCTION IN PART OR AS A WHOLE WITHOUT THE WRITTEN PERMISSION OF Doric Lenses Inc. IS PROHIBITED.

DO NOT SCALE DRAWING

| | | |
|---|--|--|
|  | | 357 rue Franquet, Quebec, QC G1P 4N7, Canada; Tel: 418 877 5600; doriclenses.com; |
| TITLE: | Generic MFP Termination for FC (KIENTEC)-3000 | |
| DWG. NO. | S212-0005 | |
| | 27-7-2022 | |

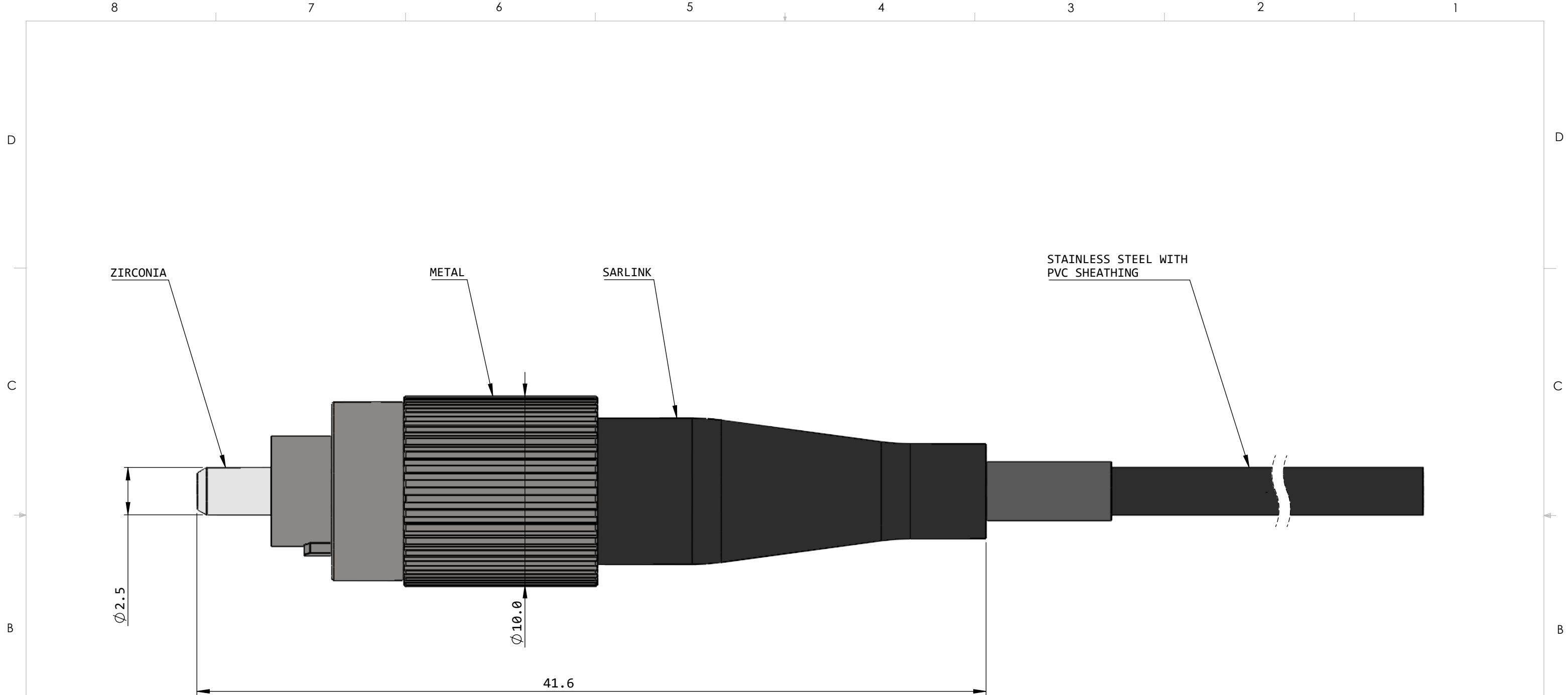

Dimensions in mm
For Information Purposes Only

PROPRIETARY
THE INFORMATION CONTAINED IN THIS DRAWING IS THE SOLE PROPERTY OF **Doric Lenses Inc.** ANY REPRODUCTION IN PART OR AS A WHOLE WITHOUT THE WRITTEN PERMISSION OF **Doric Lenses Inc.** IS PROHIBITED.

DO NOT SCALE DRAWING

| | | | |
|--------------|--|--|--|
| doric | | 357 rue Franquet, Quebec, QC G1P 4N7, Canada; Tel: 418 877 5600; doriclenses.com; | |
| TITLE: | | Generic MFP Terminaison for FC (KIENTEC)-LWMJ | |
| DWG. NO. | | S212-0006 | |
| | | 11-7-2022 | |

ZIRCONIA

METAL

SARLINK

POLYURETHANE

Ø 2.5

Ø 10.0

41.6

doric

357 rue Franquet, Quebec, QC
G1P 4N7, Canada;
Tel: 418 877 5600;
doriclenses.com;

Dimensions in mm
For Information Purposes Only

PROPRIETARY
THE INFORMATION CONTAINED IN THIS DRAWING
IS THE SOLE PROPERTY OF **Doric Lenses Inc.**..
ANY REPRODUCTION IN PART OR AS A WHOLE
WITHOUT THE WRITTEN PERMISSION OF
Doric Lenses Inc. IS PROHIBITED.

DO NOT SCALE DRAWING

TITLE:

Generic MFP Terminaison for
FC (KIENTEC)-PKMJ

DWG. NO.

S212-0167

9-8-2022

D

C

B

A

D

C

B

A

8

7

6

5

4

3

2

1

8

7

6

5

4

3

2

1

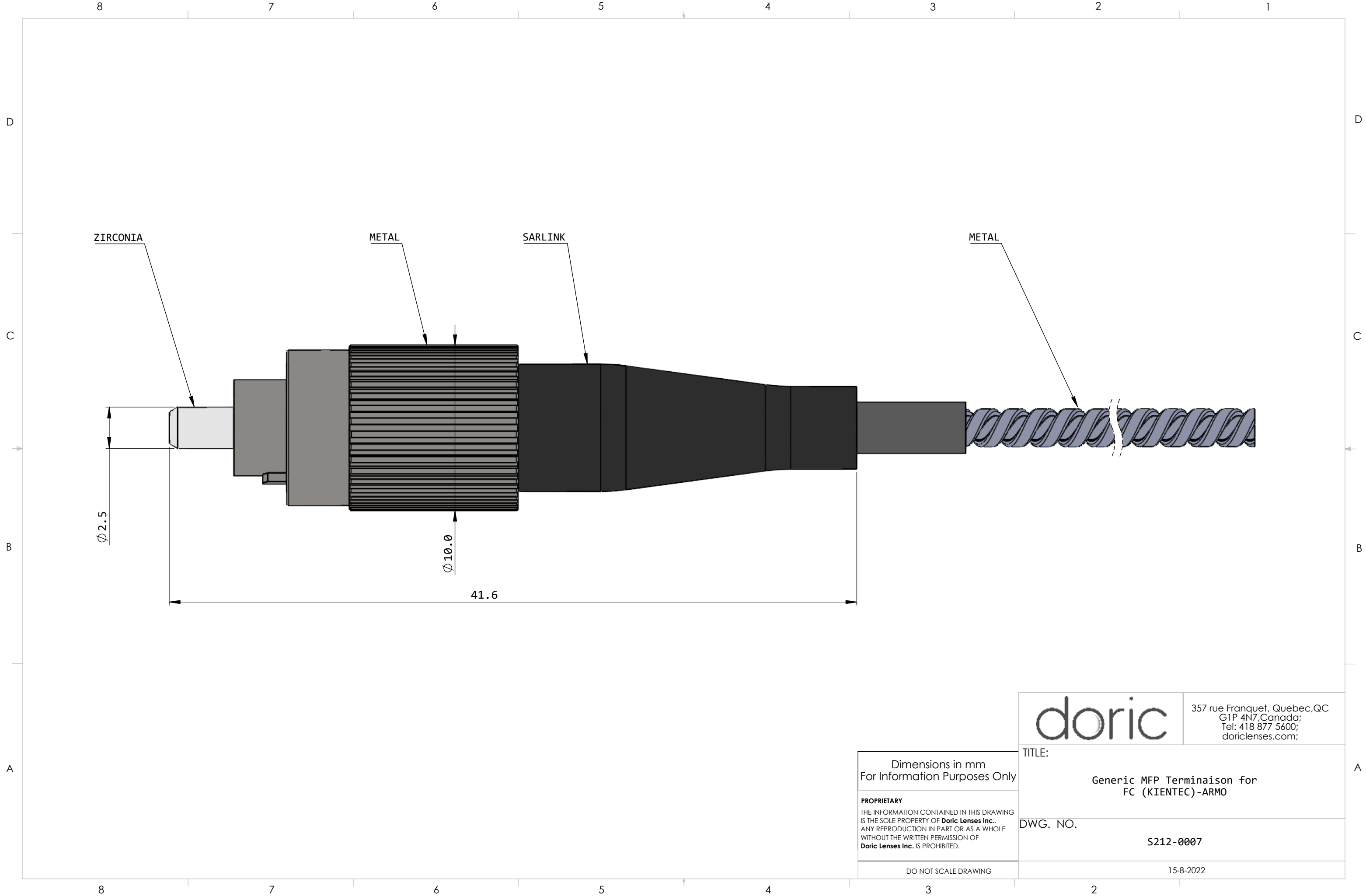

Dimensions in mm
For Information Purposes Only

PROPRIETARY
THE INFORMATION CONTAINED IN THIS DRAWING
IS THE SOLE PROPERTY OF **Doric Lenses Inc.**..
ANY REPRODUCTION IN PART OR AS A WHOLE
WITHOUT THE WRITTEN PERMISSION OF
Doric Lenses Inc. IS PROHIBITED.

DO NOT SCALE DRAWING

doric

357 rue Franquet, Quebec, QC
G1P 4N7, Canada;
Tel: 418 877 5600;
doriclenses.com;

TITLE:

Generic MFP Termination for
FC (KIENTEC)-ARMO

DWG. NO.

S212-0007

15-8-2022

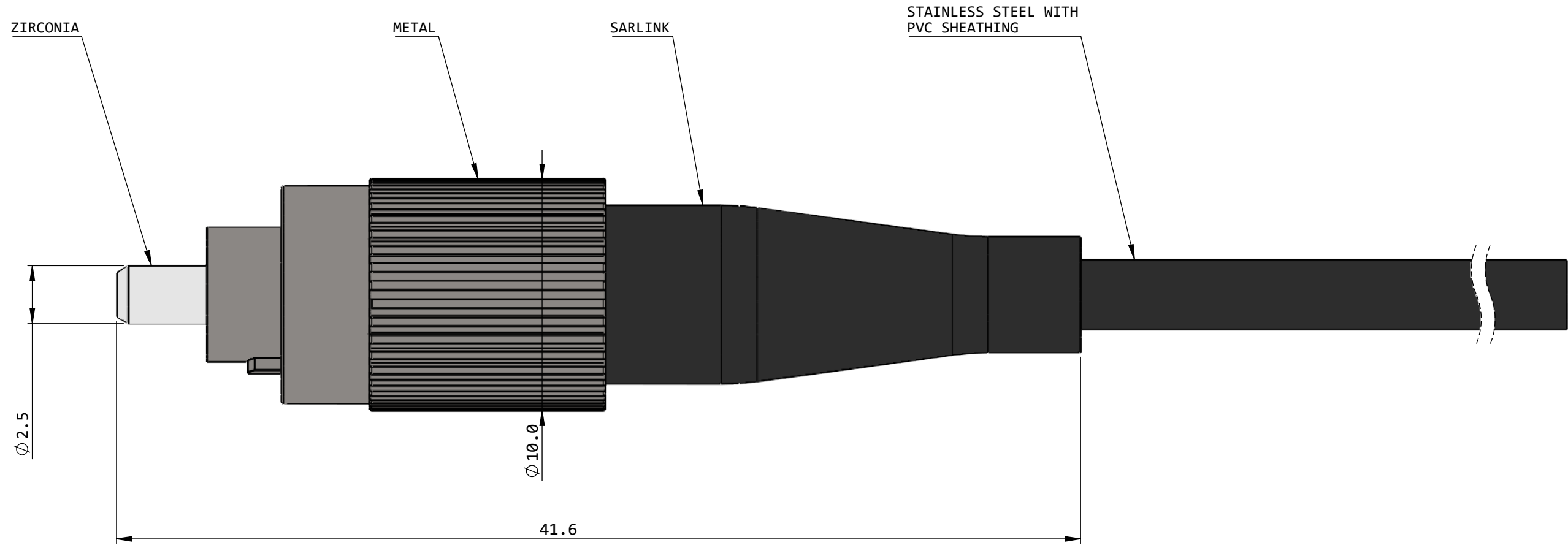

Dimensions in mm
For Information Purposes Only

PROPRIETARY
THE INFORMATION CONTAINED IN THIS DRAWING IS THE SOLE PROPERTY OF Doric Lenses Inc.. ANY REPRODUCTION IN PART OR AS A WHOLE WITHOUT THE WRITTEN PERMISSION OF Doric Lenses Inc. IS PROHIBITED.

DO NOT SCALE DRAWING

| | |
|---|--|
|  | 357 rue Franquet, Quebec, QC G1P 4N7, Canada; Tel: 418 877 5600; doriclenses.com; |
| | TITLE: Generic MFP Terminaison for FC (KIENTEC)-ARBK |
| DWG. NO. | S212-0191 |
| DO NOT SCALE DRAWING | 1-9-2022 |